



Yealink

DECT Headset-Work with Deskphone Solution

Yealink—Contents

You can click the following items to enter the related information:

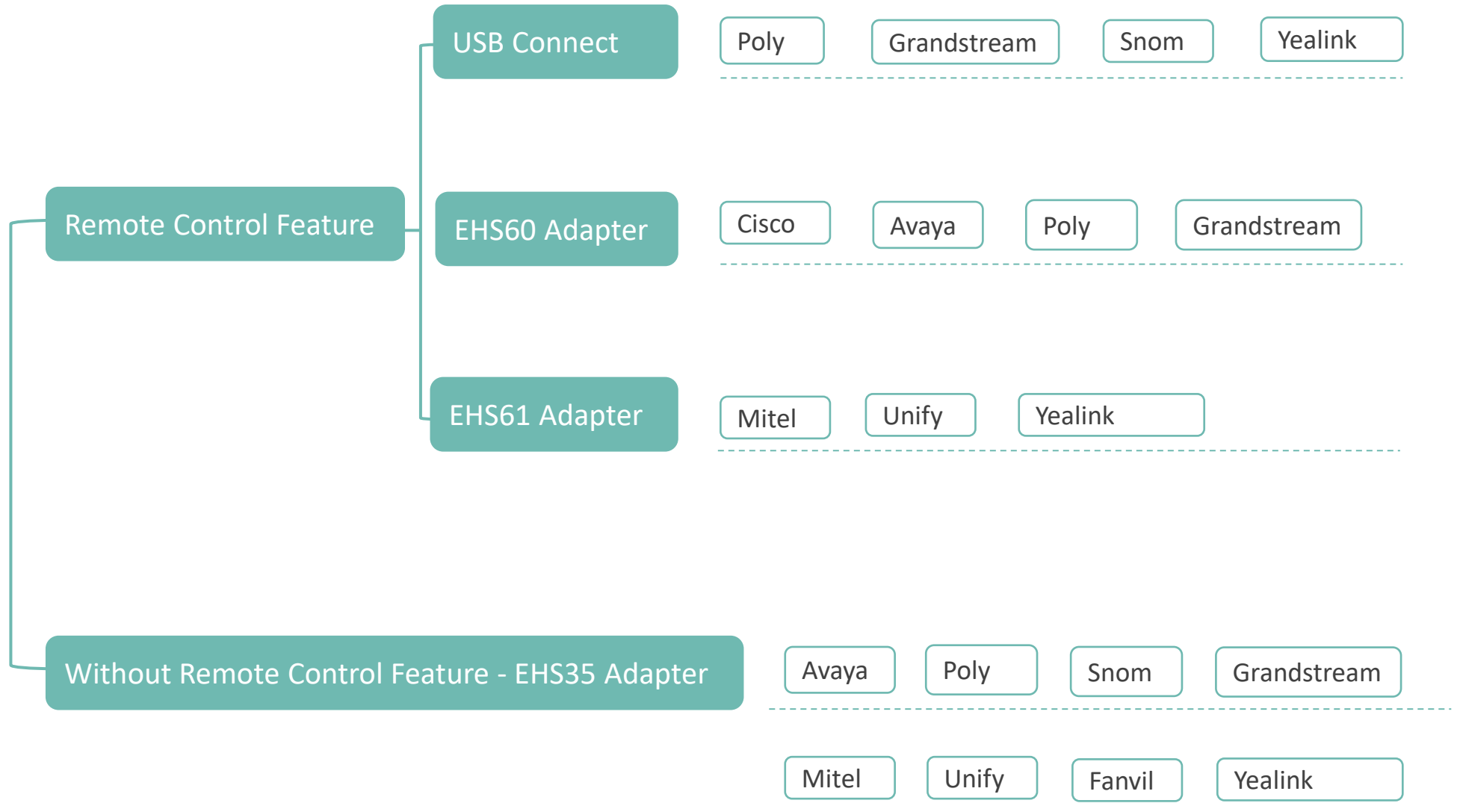

Electronic Hook Switch Cables (EHS) provide the desk phone call control with your wireless headset. We offer cables that are compatible with many of the most popular office desk phones.

USB Connect—Remote Control Feature

USB Cable for Poly Phone Models



USB Setup

Use the USB setup below to automatically answer a desk phone call by pressing a button on your WH62 or WH63 headset.

If you want to know more detailed compatibility information, please refer to <https://support.yealink.com/en/portal/compatible>.

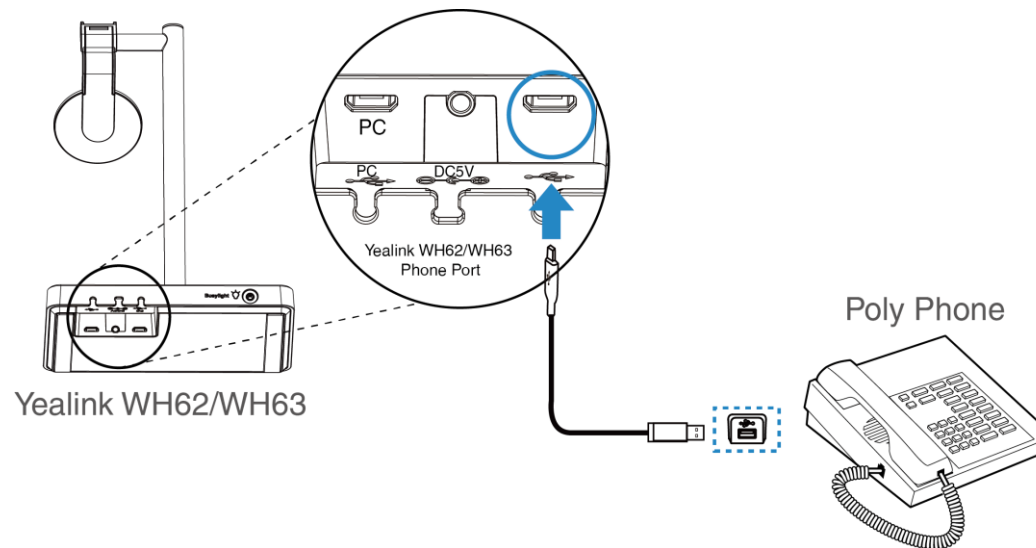

USB Connect—Remote Control Feature

USB Cable for Grandstream Phone Models



USB Setup

Use the USB setup below to automatically answer a desk phone call by pressing a button on your WH62 or WH63 headset.

If you want to know more detailed compatibility information, please refer to <https://support.yealink.com/en/portal/compatible>.

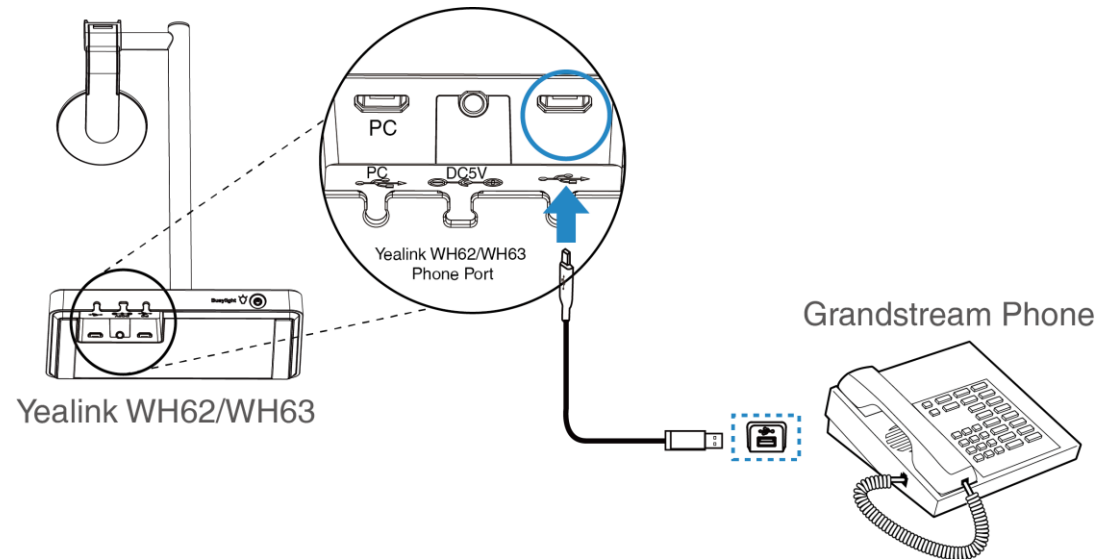

USB Connect—Remote Control Feature

USB Cable for Snom Phone Models



USB Setup

Use the USB setup below to automatically answer a desk phone call by pressing a button on your WH62 or WH63 headset.

If you want to know more detailed compatibility information, please refer to <https://support.yealink.com/en/portal/compatible>.

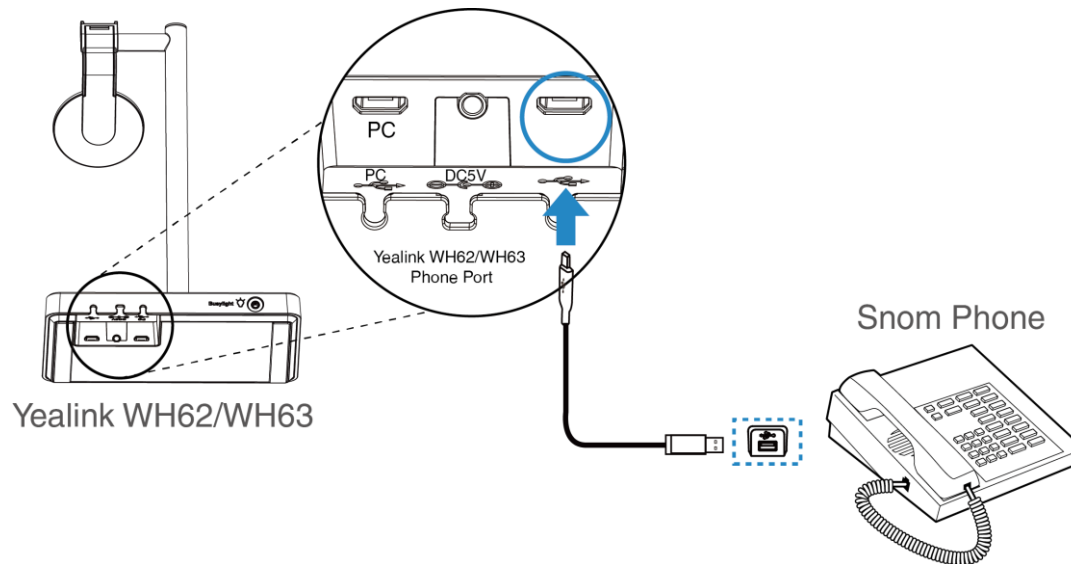

USB Connect—Remote Control Feature

USB Cable for Yealink Phone Models

Desk Phone Models:

T3X, T58, T67LTE, T4XS, T4XU,
T5XW, T2XG, T4XG, VP59, MP5X



Micro USB to USB-A Cable



WH62/WH63 Headset



USB Setup

Use the USB setup below to automatically answer a desk phone call by pressing a button on your WH62 or WH63 headset.

If you want to know more detailed compatibility information, please refer to <https://support.yealink.com/en/portal/compatible>.

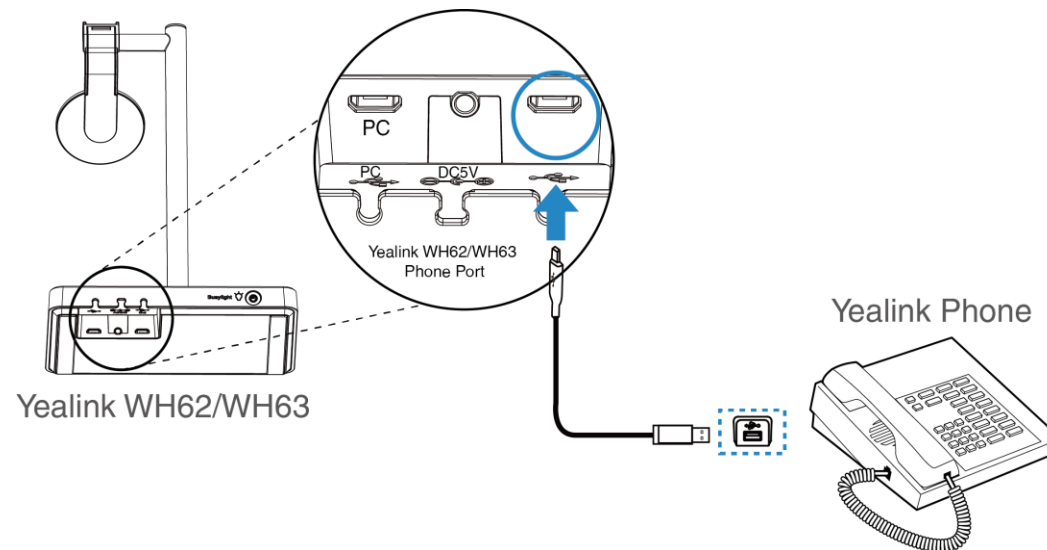

EHS60 Adapter—Remote Control Feature

Wireless Headset Adapter for Cisco Phone Models

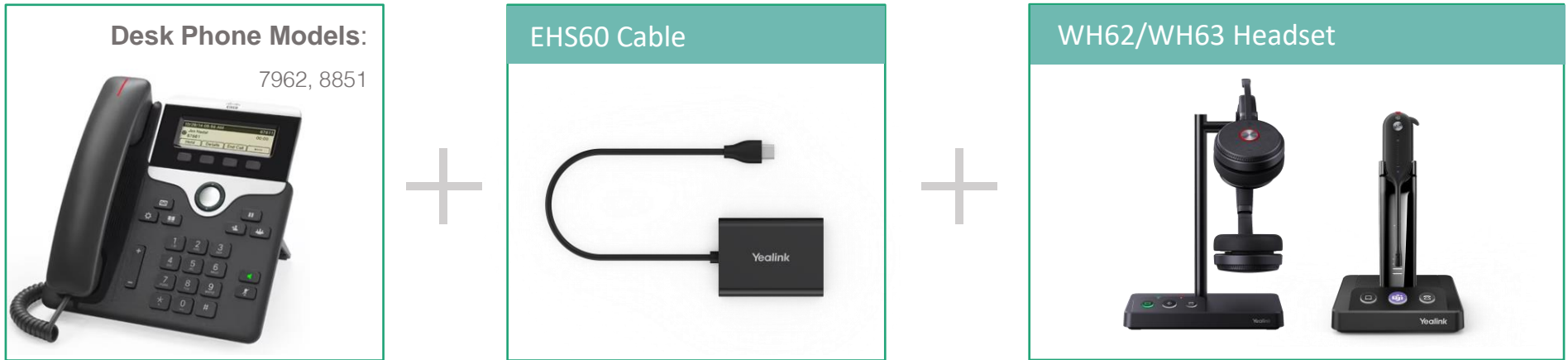

EHS Setup

- Use the EHS setup below to automatically answer a desk phone call by pressing a button on your WH62 or WH63 headset. Please refer to [EHS60 User Guide](#) for more settings information.
- If you want to know more detailed compatibility information, please refer to <https://support.yealink.com/en/portal/compatible>.

- The WH62/WH63 headset firmware version must be 104.431.0.5 or later.

You can update/check the version via [Yealink USB Connect](#).

- Only headset hardware with the following label can support EHS60.

- 1) “EHS60 Supported” is marked on the giftbox:

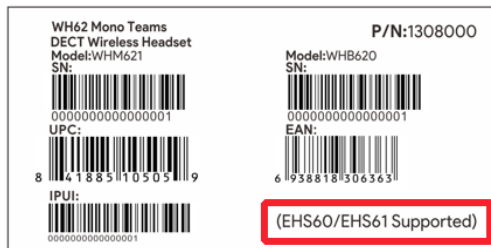

- 2) The Base is marked with EHS60 Supported:

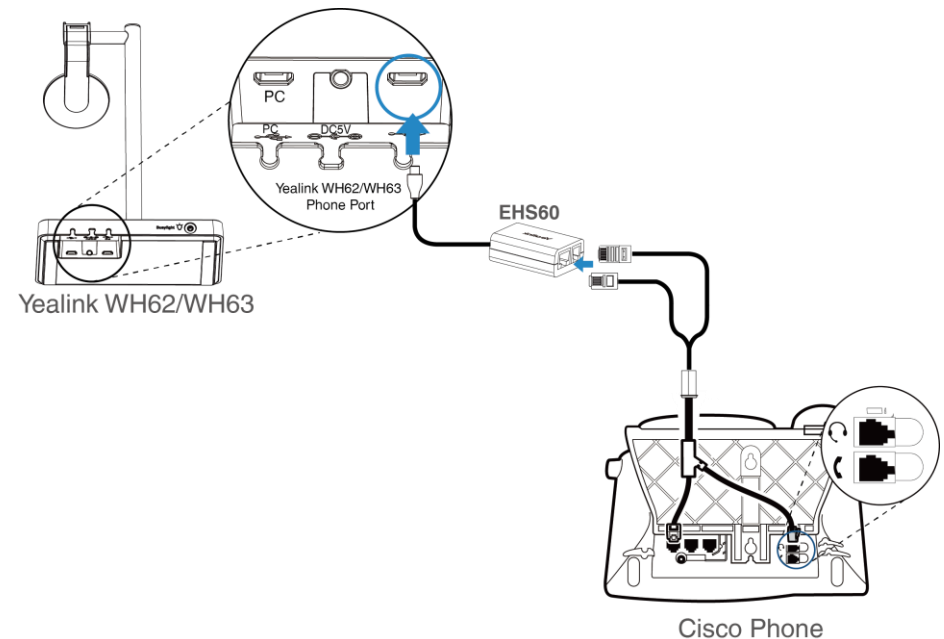
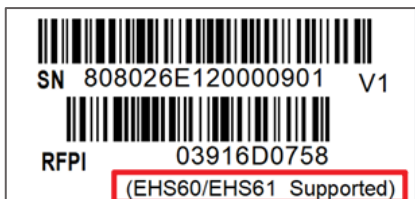

EHS60 Adapter—Remote Control Feature

Wireless Headset Adapter for **Avaya Phone Models**



EHS Setup

- Use the EHS setup below to automatically answer a desk phone call by pressing a button on your WH62 or WH63 headset. Please refer to [EHS60 User Guide](#) for more settings information.
- If you want to know more detailed compatibility information, please refer to <https://support.yealink.com/en/portal/compatible>.

- The WH62/WH63 headset firmware version must be 104.431.0.5 or later. You can update/check the version via [Yealink USB Connect](#).
- Only headset hardware with the following label can support EHS60.
- 1) “EHS60 Supported” is marked on the giftbox:

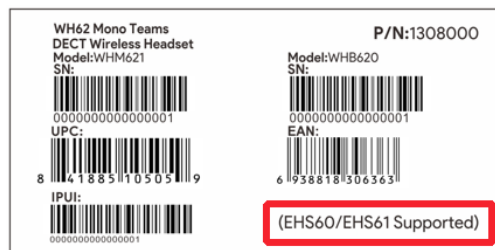

- 2) The Base is marked with EHS60 Supported:

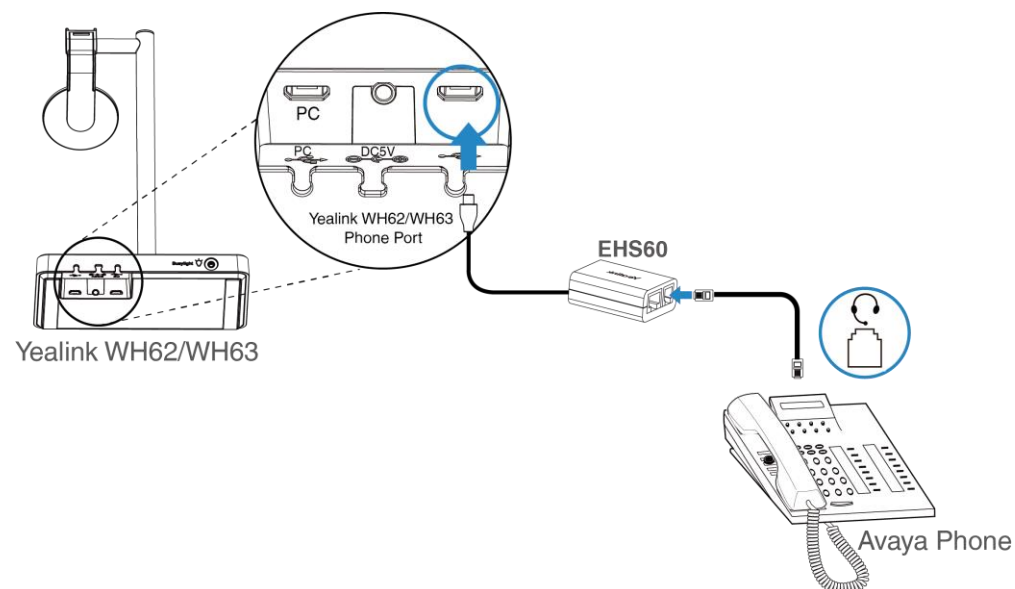

EHS60 Adapter—Remote Control Feature

Wireless Headset Adapter for Poly Phone Models



EHS Setup

- Use the EHS setup below to automatically answer a desk phone call by pressing a button on your WH62 or WH63 headset. Please refer to [EHS60 User Guide](#) for more settings information.
- If you want to know more detailed compatibility information, please refer to <https://support.yealink.com/en/portal/compatible>.

- The WH62/WH63 headset firmware version must be 104.431.0.5 or later. You can update/check the version via [Yealink USB Connect](#).
- Only headset hardware with the following label can support EHS60.
- 1) “EHS60 Supported” is marked on the giftbox:

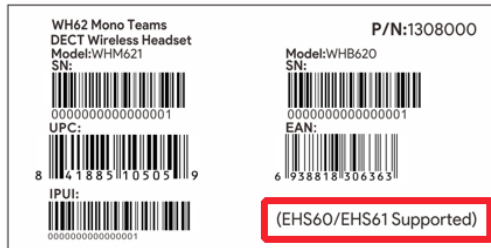

- 2) The Base is marked with EHS60 Supported:

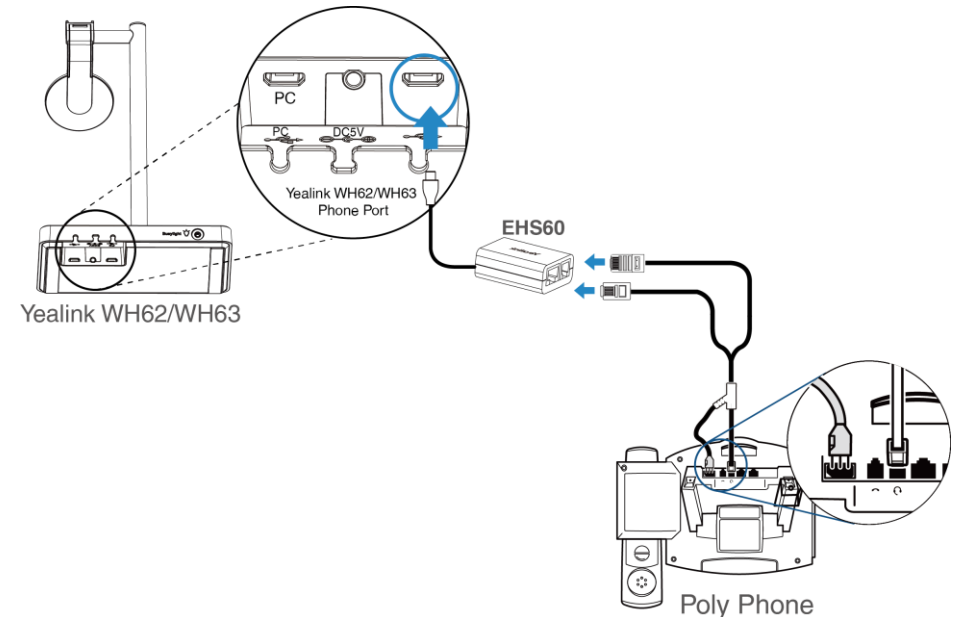
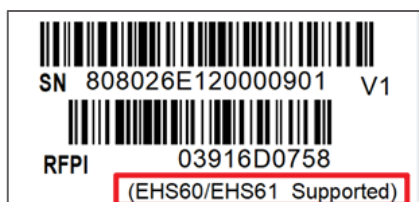

EHS60 Adapter—Remote Control Feature

Wireless Headset Adapter for Grandstream Phone Models



EHS Setup

- Use the EHS setup below to automatically answer a desk phone call by pressing a button on your WH62 or WH63 headset. Please refer to [EHS60 User Guide](#) for more settings information.
- If you want to know more detailed compatibility information, please refer to <https://support.yealink.com/en/portal/compatible>.

- The WH62/WH63 headset firmware version must be 104.431.0.5 or later. You can update/check the version via [Yealink USB Connect](#).
 - Only headset hardware with the following label can support EHS60.
- 1) “EHS60 Supported” is marked on the giftbox:

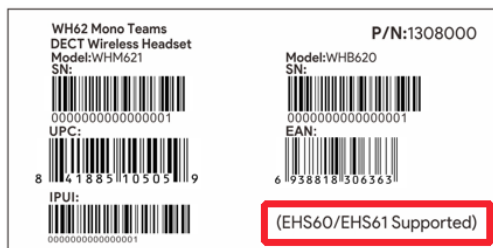

- 2) The Base is marked with EHS60 Supported:

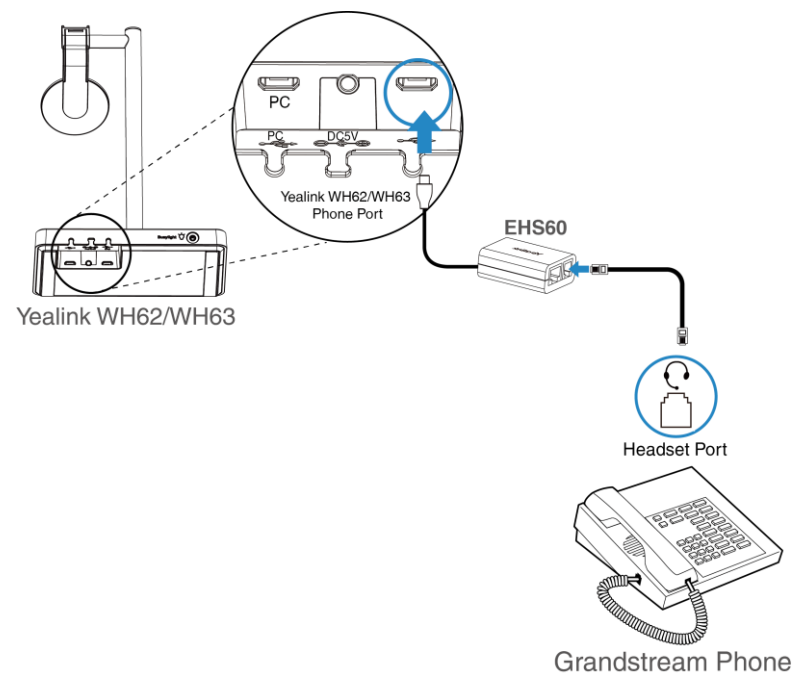
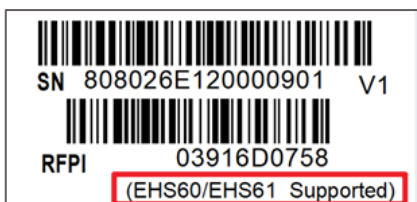

EHS61 Adapter—Remote Control Feature

Wireless Headset Adapter for **Mitel Phone Models**

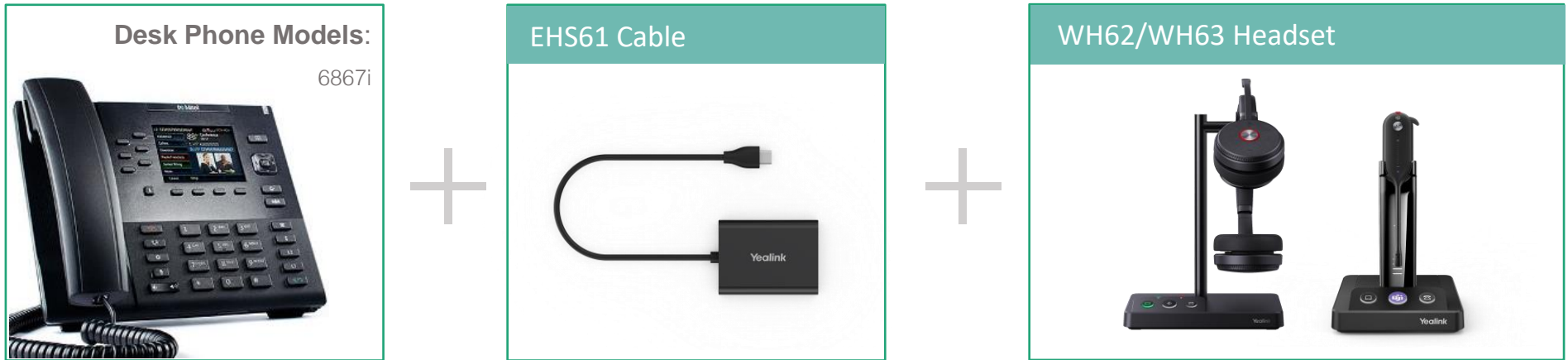

EHS Setup

- Use the EHS setup below to automatically answer a desk phone call by pressing a button on your WH62 or WH63 headset. Please refer to [EHS61 User Guide](#) for more settings information.
- If you want to know more detailed compatibility information, please refer to <https://support.yealink.com/en/portal/compatible>.

- The WH62/WH63 headset firmware version must be 104.433.0.20 or later. You can update/check the version via [Yealink USB Connect](#).
- Only headset hardware with the following label can support EHS61.

- 1) “EHS61 Supported” is marked on the giftbox:

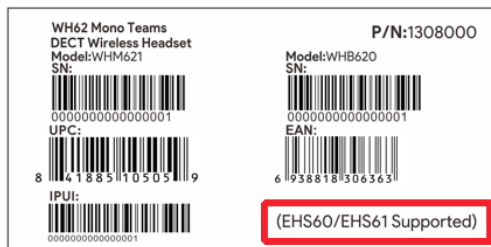

- 2) The Base is marked with EHS61 Supported:

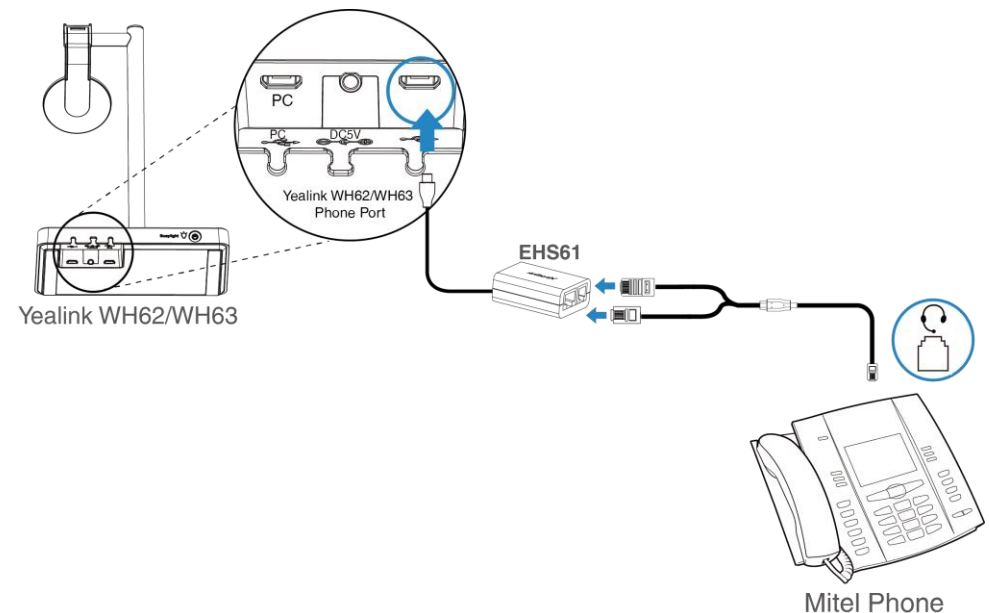
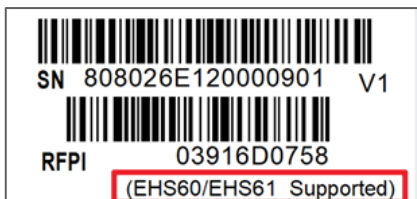

EHS61 Adapter—Remote Control Feature

Wireless Headset Adapter for **Unify Phone Models**

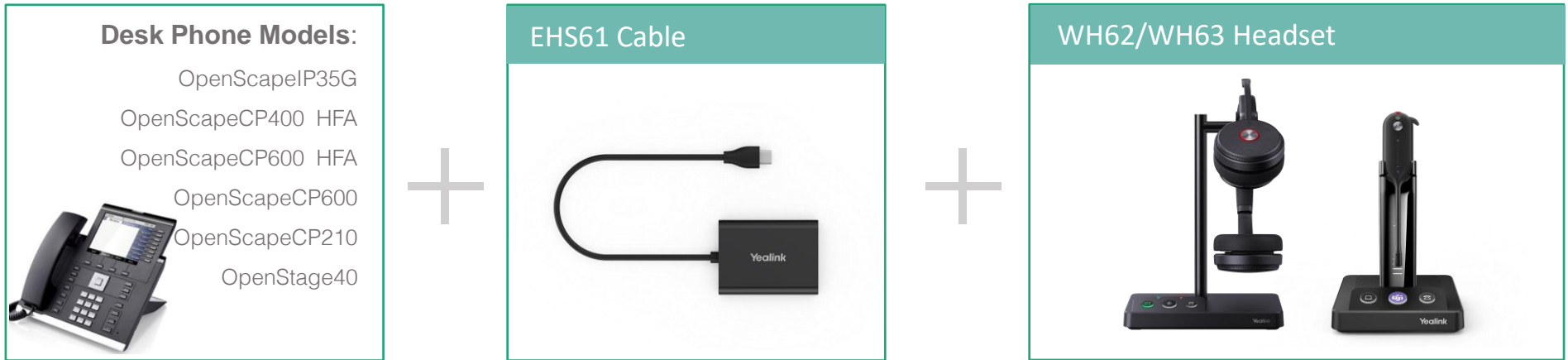

EHS Setup

- Use the EHS setup below to automatically answer a desk phone call by pressing a button on your WH62 or WH63 headset. Please refer to [EHS61 User Guide](#) for more settings information.
- If you want to know more detailed compatibility information, please refer to <https://support.yealink.com/en/portal/compatible>.

- The WH62/WH63 headset firmware version must be 104.433.0.20 or later. You can update/check the version via [Yealink USB Connect](#).
- Only headset hardware with the following can support EHS61.

- 1) “EHS61 Supported” is marked on the giftbox:

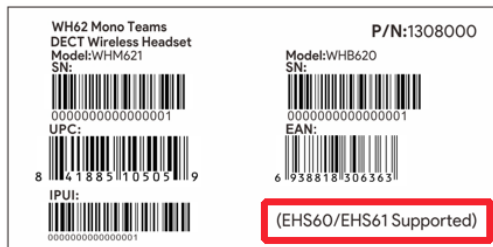

- 2) The Base is marked with EHS61 Supported:

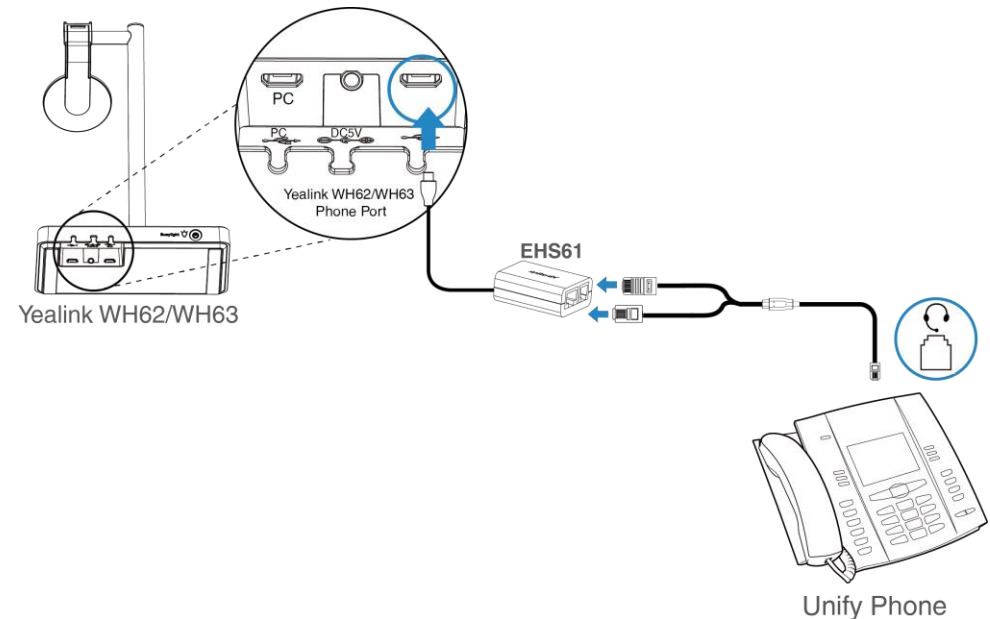
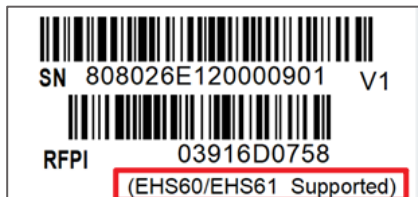

EHS61 Adapter—Remote Control Feature

Wireless Headset Adapter for Yealink Phone Models



EHS Setup

- Use the EHS setup below to automatically answer a desk phone call by pressing a button on your WH62 or WH63 headset. Please refer to [EHS61 User Guide](#) for more settings information.
- If you want to know more detailed compatibility information, please refer to <https://support.yealink.com/en/portal/compatible>.

- The WH62/WH63 headset firmware version must be 104.433.0.20 or later. You can update/check the version via [Yealink USB Connect](#).
 - Only headset hardware with the following can support EHS61.
- 1) “EHS61 Supported” is marked on the giftbox:

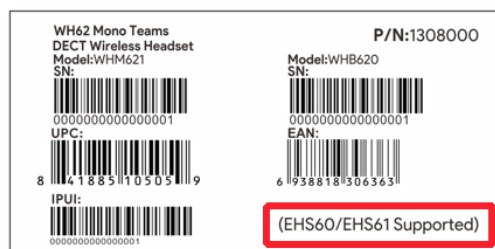

- 2) The Base is marked with EHS61 Supported:

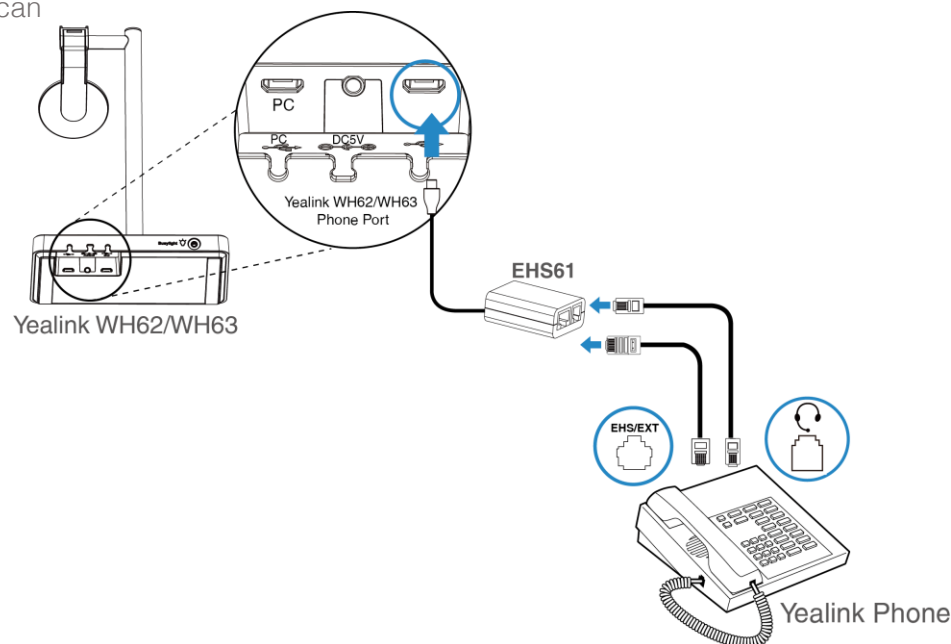

EHS35 Adapter—Without Remote Control Feature

Wireless Headset Adapter for Avaya Phone Models



+



+



EHS Setup

- The EHS35 can not control the call and only transmit audio, please refer to [EHS35 User Guide](#) for more settings information.
- The WH62/WH63 headset firmware version must be 104.433.0.15 or later.
- If you want to know more detailed compatibility information, please refer to <https://support.yealink.com/en/portal/compatible>.

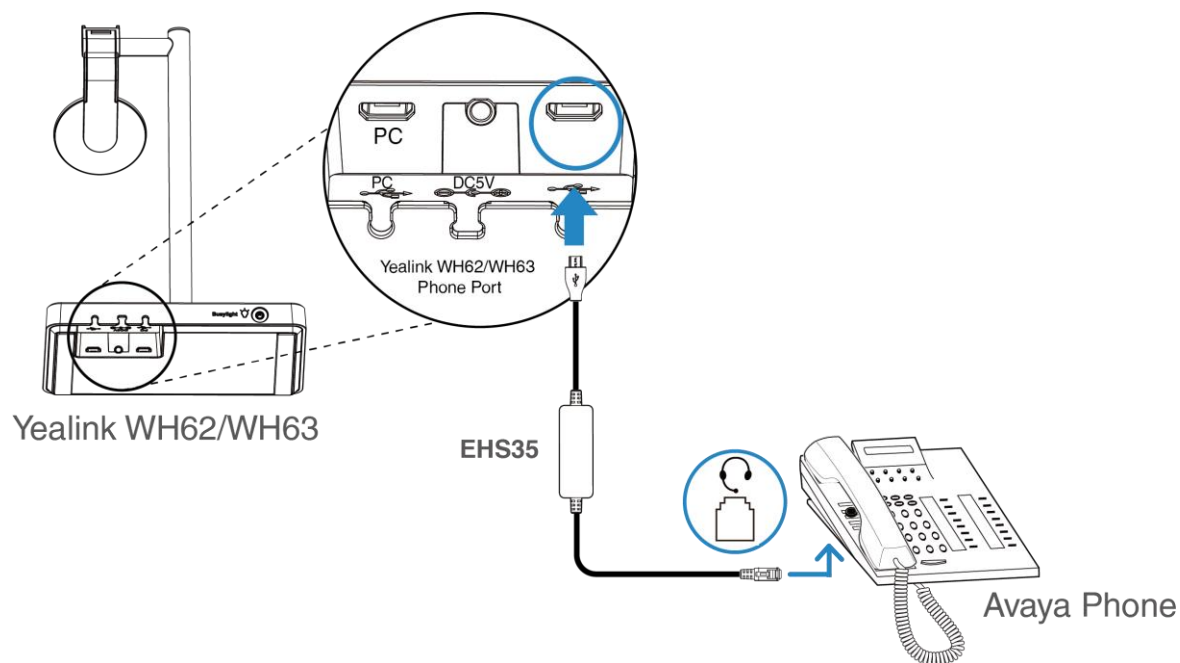

EHS35 Adapter—Without Remote Control Feature

Wireless Headset Adapter for Poly Phone Models



+



+



EHS Setup

- The EHS35 can not control the call and only transmit audio, please refer to [EHS35 User Guide](#) for more settings information.
- The WH62/WH63 headset firmware version must be 104.433.0.15 or later.
- If you want to know more detailed compatibility information, please refer to <https://support.yealink.com/en/portal/compatible>.

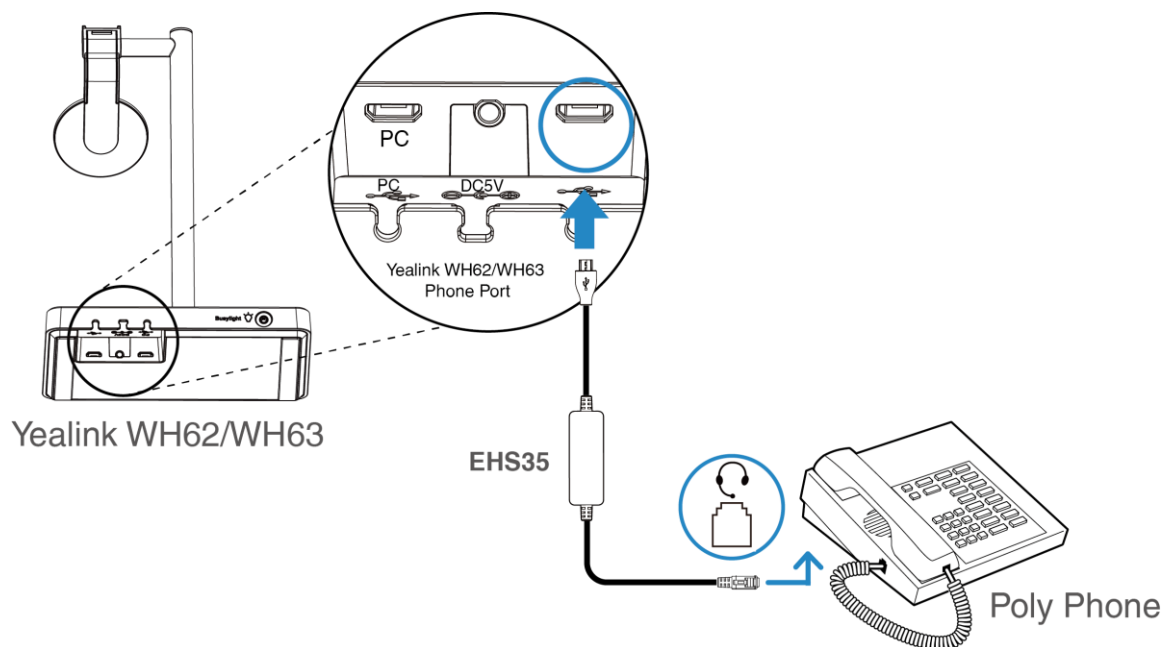

EHS35 Adapter—Without Remote Control Feature

Wireless Headset Adapter for Snom Phone Models

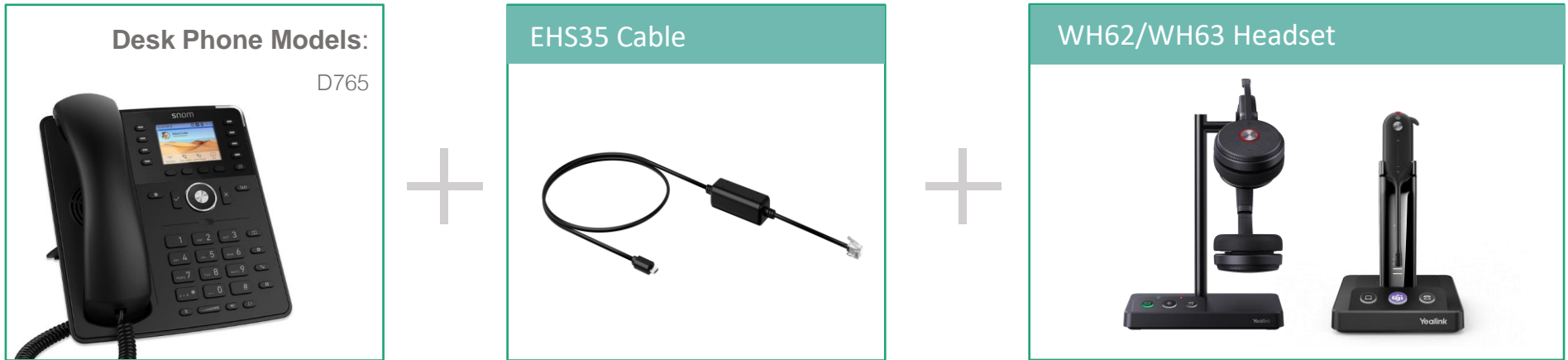

EHS Setup

- The EHS35 can not control the call and only transmit audio, please refer to [EHS35 User Guide](#) for more settings information.
- The WH62/WH63 headset firmware version must be 104.433.0.15 or later.
- If you want to know more detailed compatibility information, please refer to <https://support.yealink.com/en/portal/compatible>.

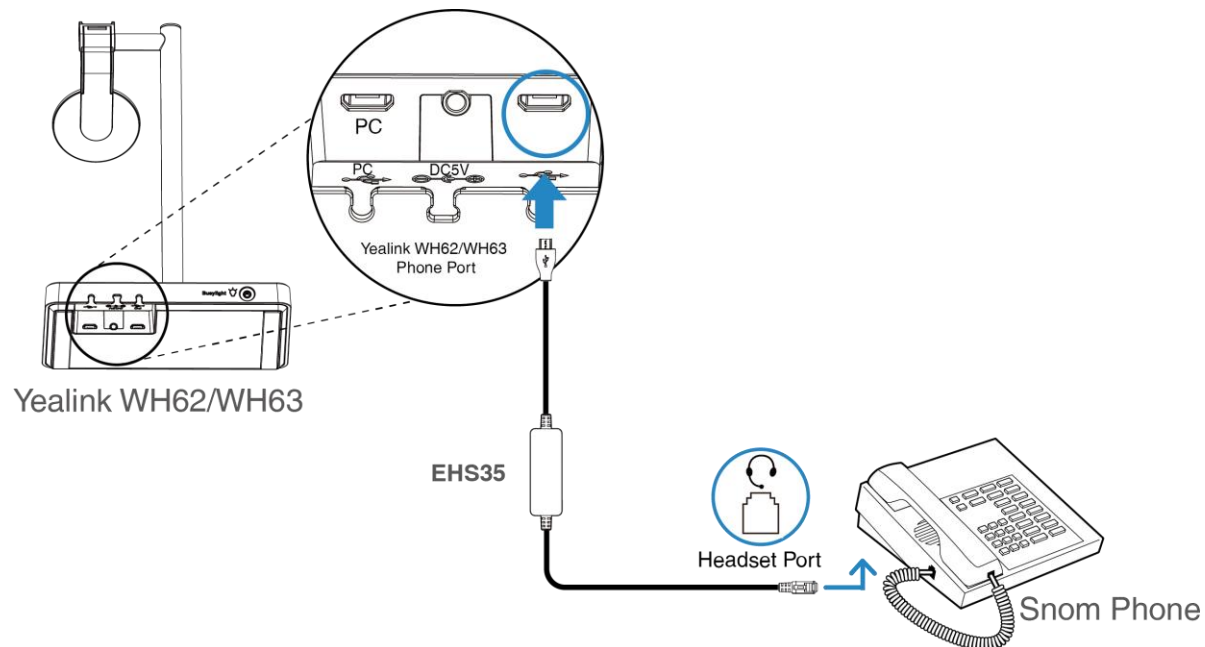

EHS35 Adapter—Without Remote Control Feature

Wireless Headset Adapter for Grandstream Phone Models

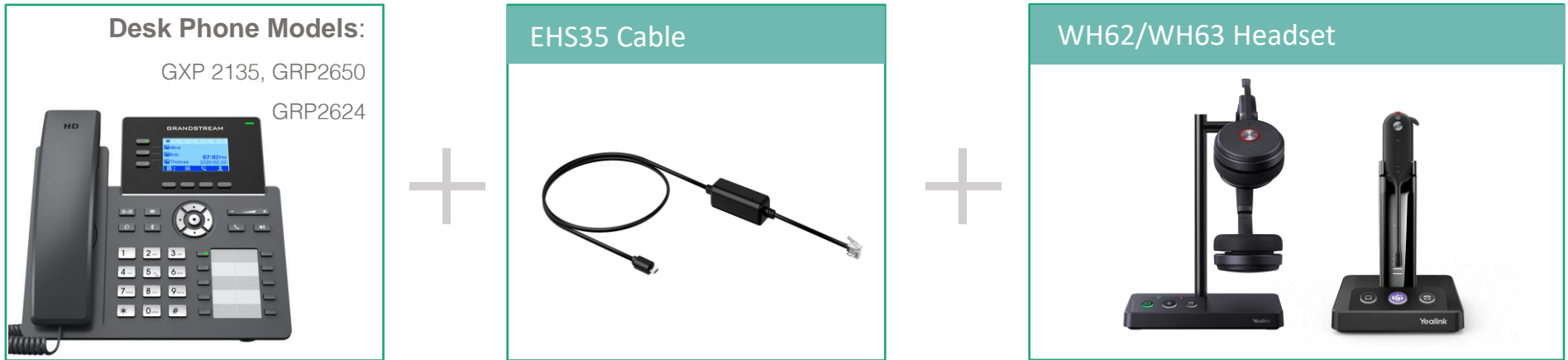

EHS Setup

- The EHS35 can not control the call and only transmit audio, please refer to [EHS35 User Guide](#) for more settings information.
- The WH62/WH63 headset firmware version must be 104.433.0.15 or later.
- If you want to know more detailed compatibility information, please refer to <https://support.yealink.com/en/portal/compatible>.

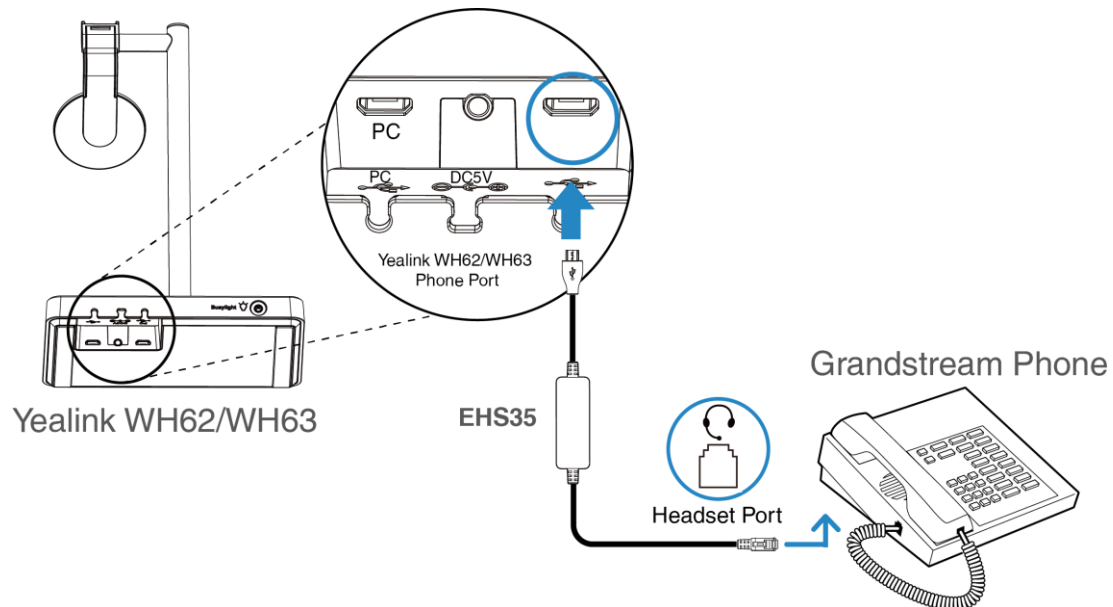

EHS35 Adapter—Without Remote Control Feature

Wireless Headset Adapter for **Mitel Phone Models**

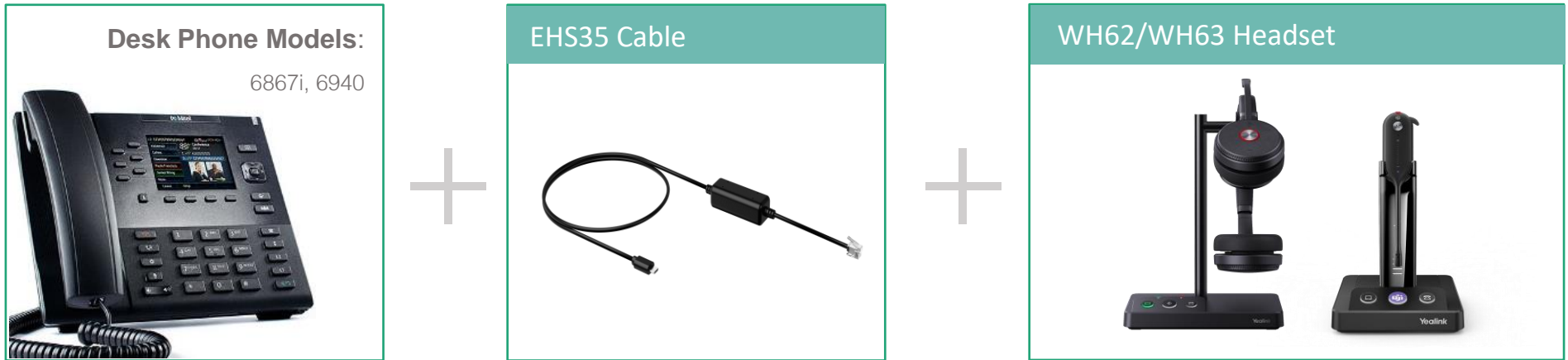

EHS Setup

- The EHS35 can not control the call and only transmit audio, please refer to [EHS35 User Guide](#) for more settings information.
- The WH62/WH63 headset firmware version must be 104.433.0.15 or later.
- If you want to know more detailed compatibility information, please refer to <https://support.yealink.com/en/portal/compatible>.

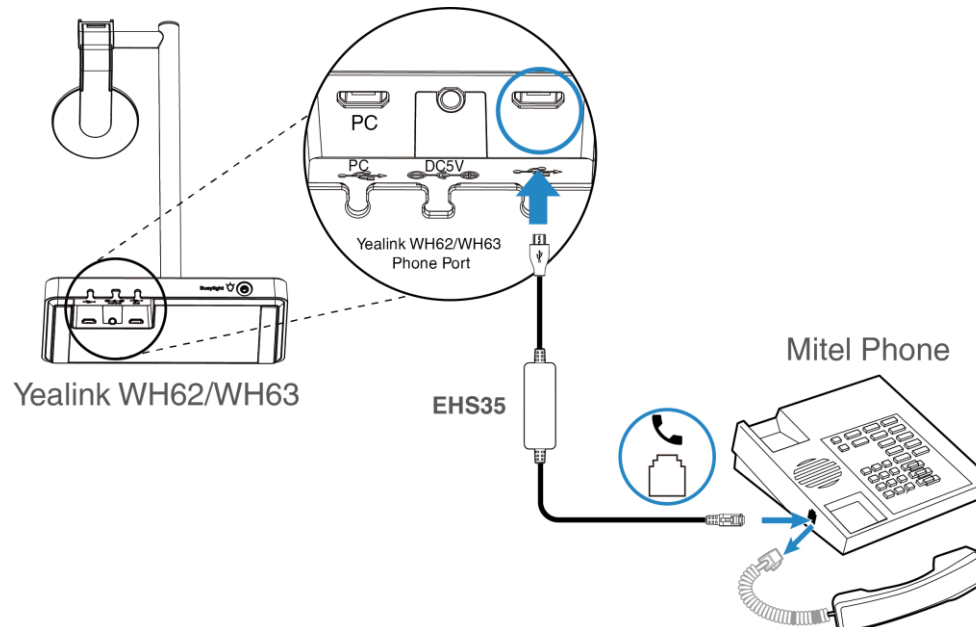

EHS35 Adapter—Without Remote Control Feature

Wireless Headset Adapter for **Unify Phone Models**

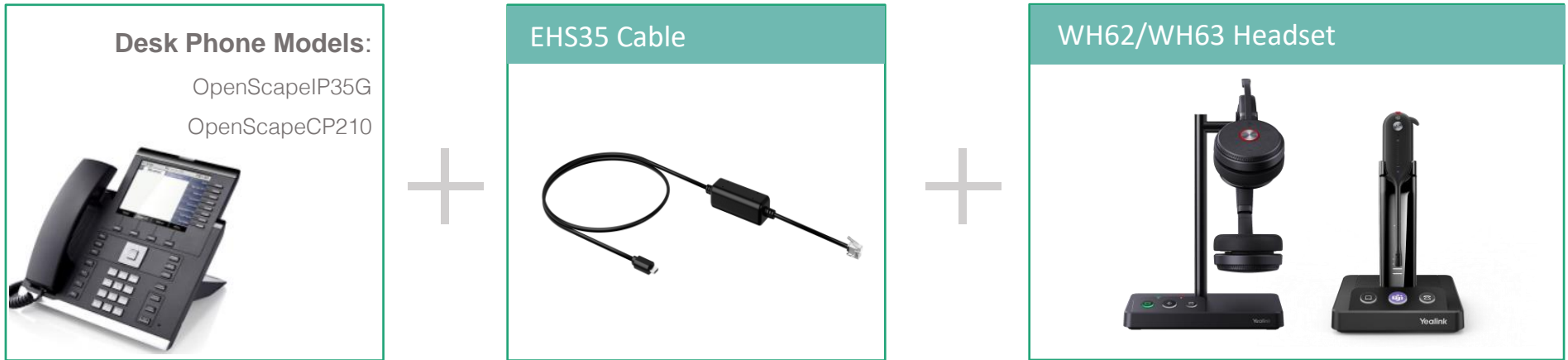

EHS Setup

- The EHS35 can not control the call and only transmit audio, please refer to [EHS35 User Guide](#) for more settings information.
- The WH62/WH63 headset firmware version must be 104.433.0.15 or later.
- If you want to know more detailed compatibility information, please refer to <https://support.yealink.com/en/portal/compatible>.

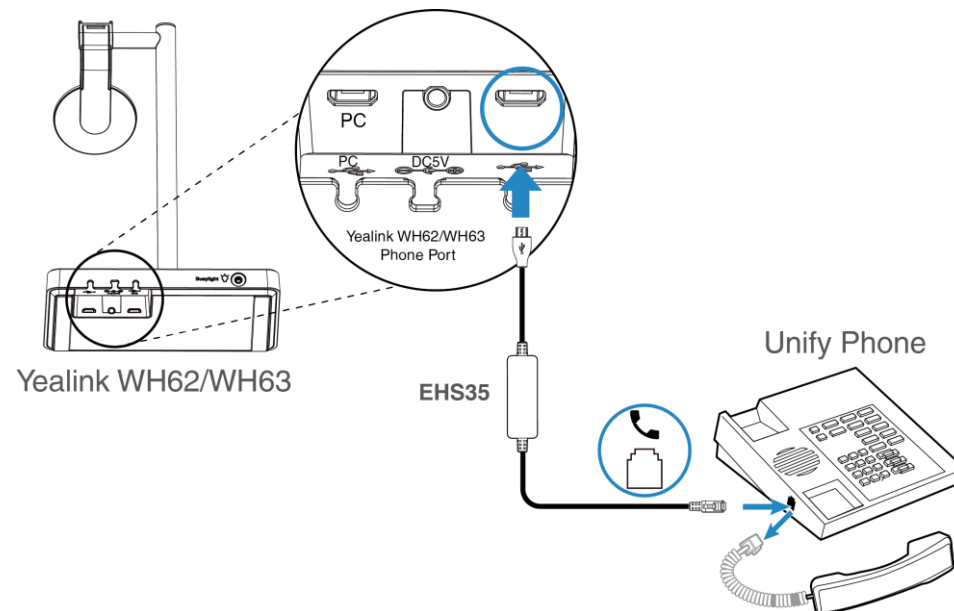

EHS35 Adapter—Without Remote Control Feature

Wireless Headset Adapter for Fanvil Phone Models

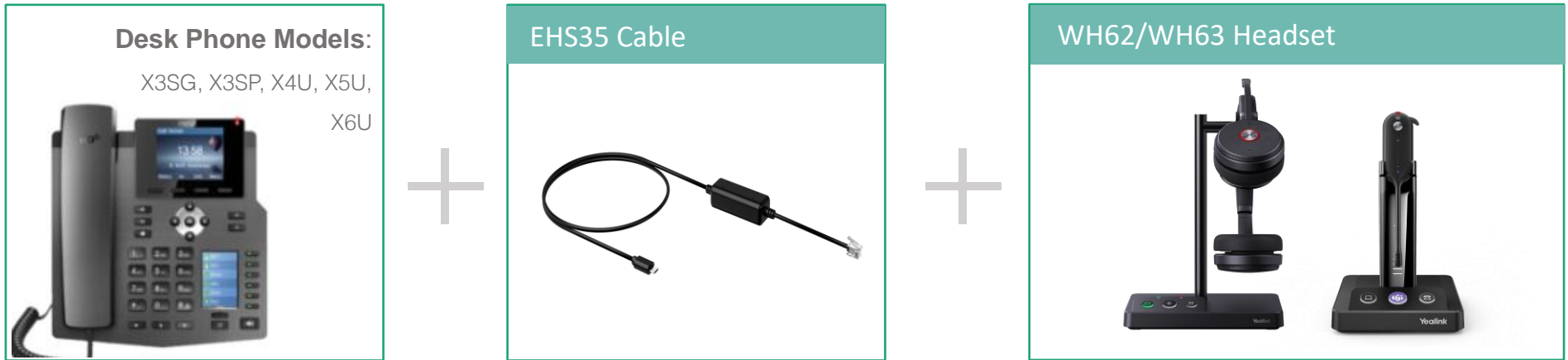

EHS Setup

- The EHS35 can not control the call and only transmit audio, please refer to [EHS35 User Guide](#) for more settings information.
- The WH62/WH63 headset firmware version must be 104.433.0.15 or later.
- If you want to know more detailed compatibility information, please refer to <https://support.yealink.com/en/portal/compatible>.

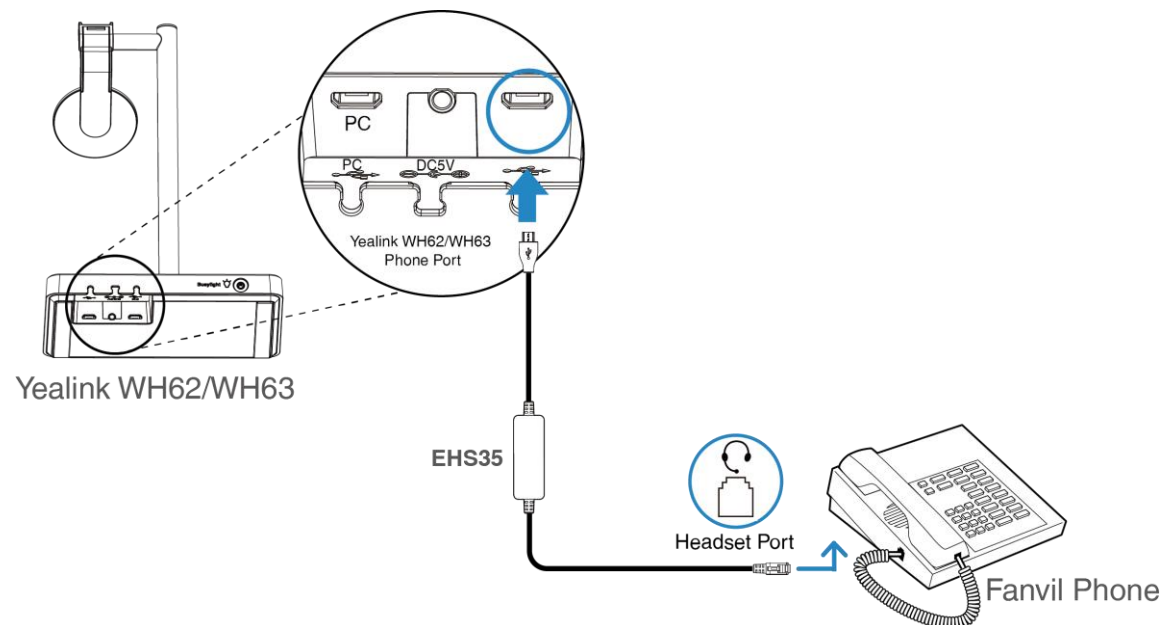

EHS35 Adapter—Without Remote Control Feature

Wireless Headset Adapter for **Yealink Phone Models**



EHS Setup

The WH62/WH63 headset firmware version must be 104.433.0.15 or later.

If you want to know more detailed compatibility information, please refer to <https://support.yealink.com/en/portal/compatible>.

Note:

- Connect to Yealink T3X series phones: EHS35 supports WH62/WH63 to control phone calls and transmit audio, please refer to [EHS35 User Guide](#) for more settings information.
- Connect to Yealink T58, T67LTE, T4XS, T4XU, T5XW, T2XG, T4XG, VP59, MP5X: EHS35 can only transmit audio, please refer to [EHS35 User Guide](#) for more settings information.

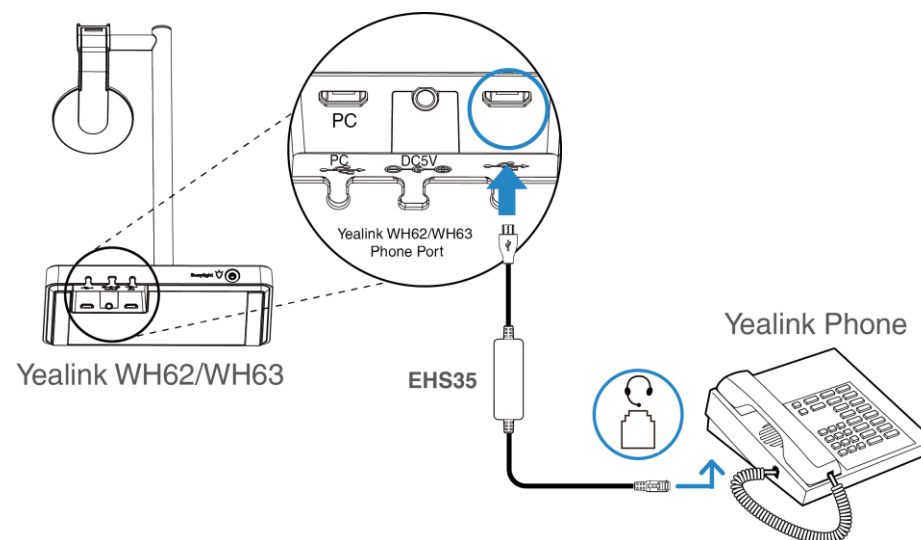

Yealink