

W59R Quick Start

Package Contents

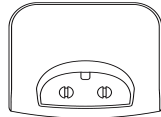

W59R Handset



Charging Cradle



Power Adapter



Battery Cover

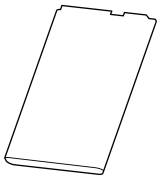

Rechargeable Battery

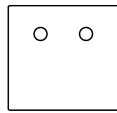

Decorative Cover

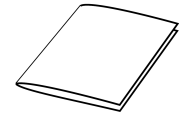

Quick Start Guide

TIP

We recommend that you use the accessories provided or approved by Yealink. The use of unapproved third-party accessories may result in reduced performance.

Assemble W59R

1. Insert the battery into the handset.

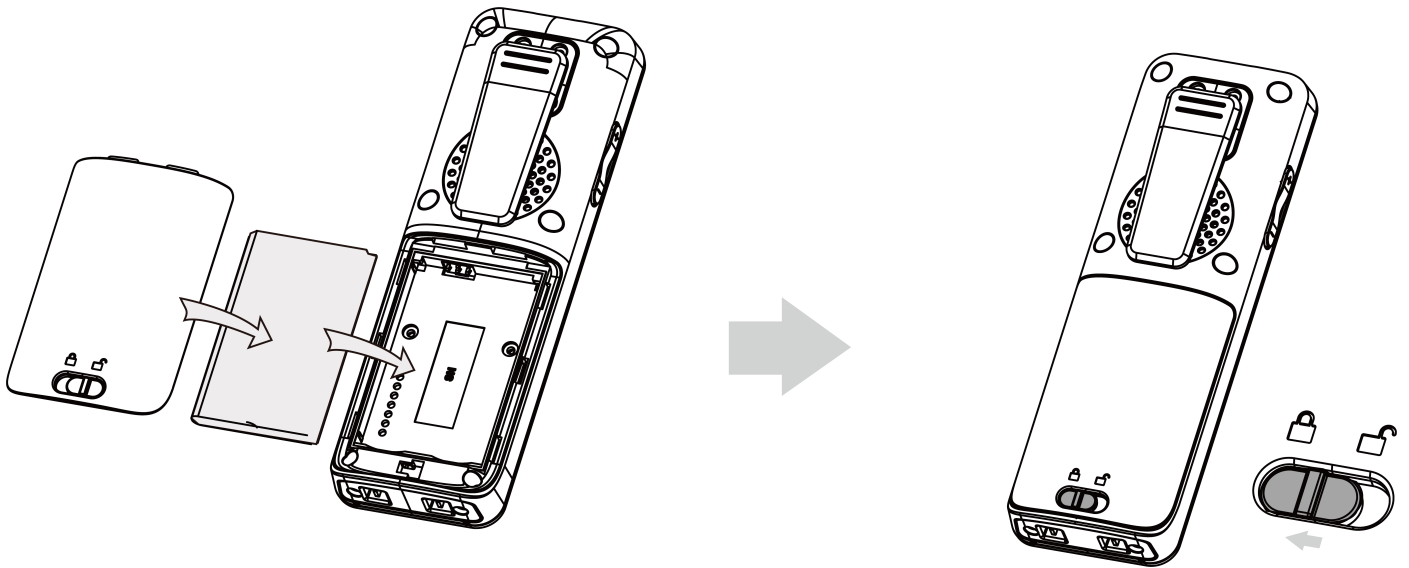

2. (Optional) Mount the charging cradle to the wall.

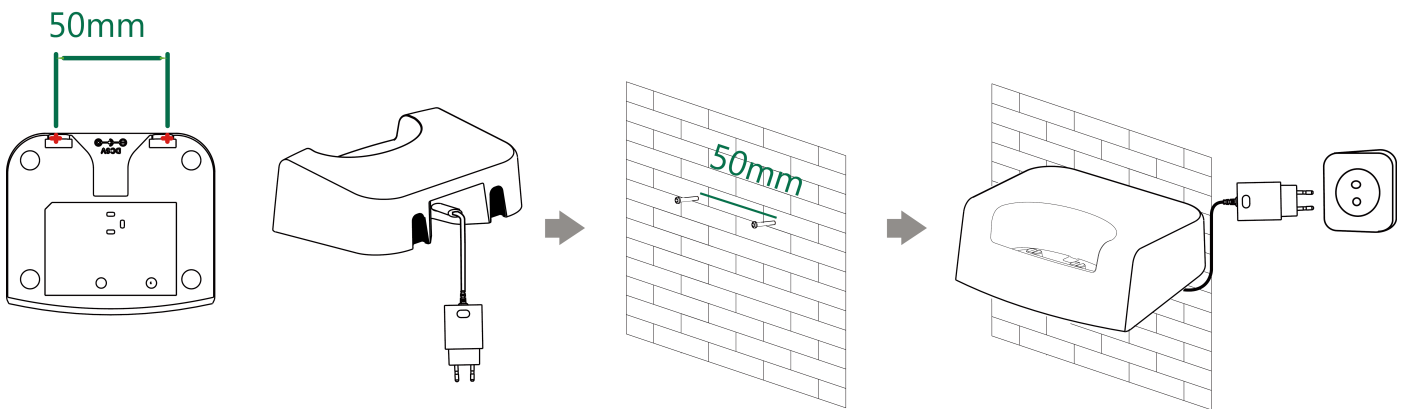

3. Connect the charging cradle and charge the handset.

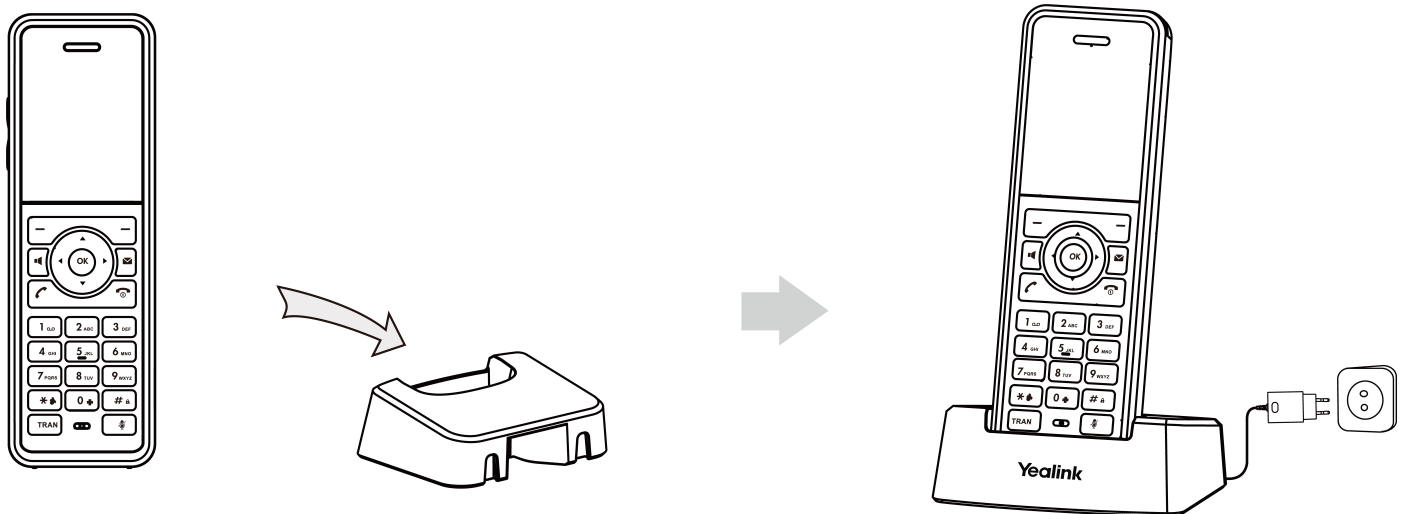

TIP

- Use Yealink-supplied power adapter (5 V/0.6 A). A third-party power adapter may damage the handset.
- Check the charging status on the top-right corner of the LCD screen.

Hardware Introduction

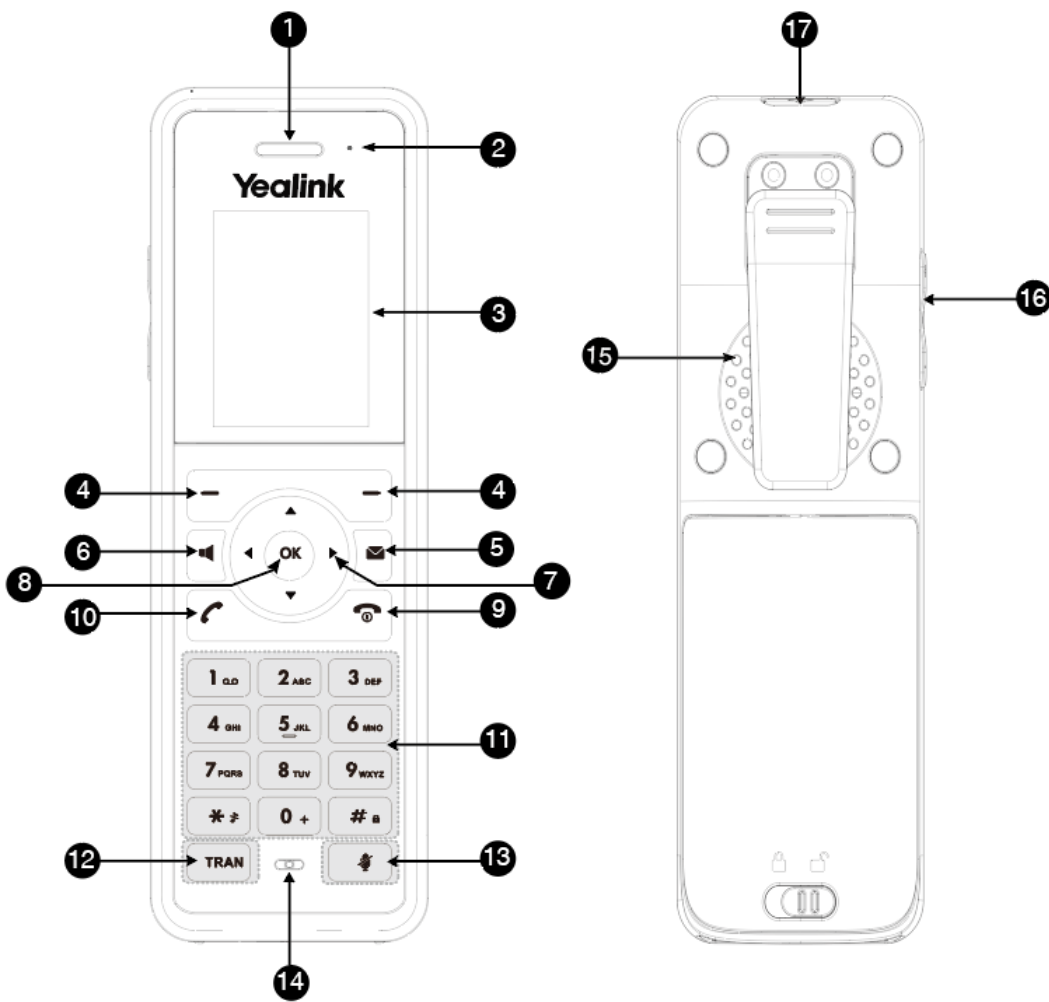

No.	Item	Description
1	Receiver	Receive audio in receiver mode.
2	Power LED Indicator	Indicate call status, message status, and charging status.
3	Phone Screen	Show information.
4	Soft Keys	Access the function directly. It depends on the operating situation.
5	Message Key	Access the voice mail or missed call.
6	Speakerphone Key	<ul style="list-style-type: none">• Switch among the receiver, headset, and hands-free modes.• Answer an incoming call.• Place a call in hands-free mode.

7	Navigation Keys	Scroll through information or options on the screen.
8	OK Key	Confirm actions or enters the main menu.
9	On-hook Key /Power Key	<ul style="list-style-type: none">• Press briefly to return to the previous screen.• Long press to return to the idle screen.• Press to turn the handset on.• Long press on the idle screen to turn the handset off.• Cancel actions or ends a call.• Reject an incoming call.
10	Off-hook Key	<ul style="list-style-type: none">• Answers an incoming call.• Enters the redial calls list.• Places a call in receiver or headset mode.
11	Keypad	Provide digits, letters, and special characters.
12	TRANSFER Key	Transfer a call to another party.
13	Mute Key	Toggle mute feature on or off.
14	Microphone	Pick up audio.

1 5	Sp eak er	Output audio in hands-free mode.
1 6	Vol um e Key +/-	Adjust the volume.
1 7	Em erg enc y Ala rm But ton	Long press 2 seconds to set off the emergency alarm. Note: The settings for this button are configured on the DM/base station where the handset is registered. They cannot be set or changed on the handset. Contact your administrator for more information on which alarm type pressing the alarm button will initiate and whether it is possible to terminate the alarm from the handset.

Power LED Indicator

LED Status	Description
Solid red	The handset is charging.
Fast flashing red (300 ms)	The handset is ringing.
Slowly flashing red (1 s)	The handset receives a voice mail or has a missed call.
Off	<ul style="list-style-type: none"> The handset is powered off. The handset is idle. The handset is fully charged.

Screen and Icons Introduction

The user screens and icon indicators can help you navigate and understand the important information on the phone's status.

Idle Screen and Icons



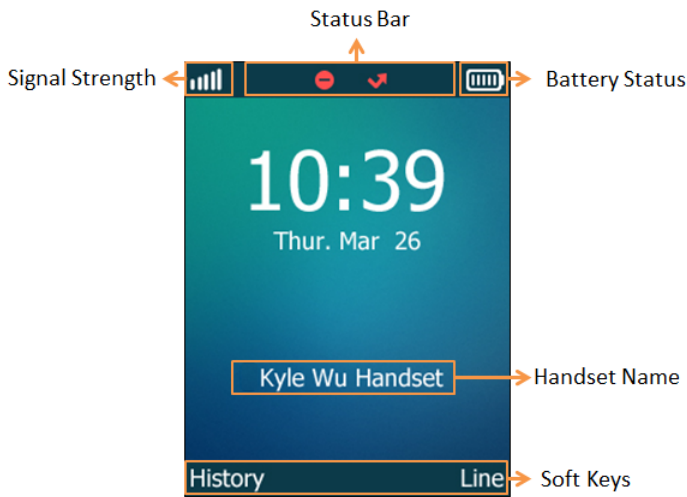

The idle screen is made up of the signal strength, battery status, status bar, handset name, and soft keys. The time & date is displayed in the middle of the screen.



Idle screen introduction

Items	Introductions
Signal Strength	<ul style="list-style-type: none"> Weak to strong: No reception: Eco mode+ is on:
Battery Status	<ul style="list-style-type: none"> Low to full: Need Charging:
Status Bar	Displays the feature status icons. The status icons are displayed when features are activated.
Handset Name	Displays internal handset number and registered handset name (for example, “1” is internal handset number, indicating the handset is the Handset 1 of the base station).
Soft Keys	The soft key labels on the screen directly above the soft keys show the functions available at that particular moment.

Icon introduction

Icons	Description
	The ringer volume is 0 and the phone is in the silent mode.
	The phone has enabled the Call Forward feature.
	The keypad is locked.
	The phone has new voice mails.
	The phone has enabled the Do Not Disturb (DND) feature.

Line Status Screen and Icons

The line status screen is made up of the outgoing line and line status.

When the handset is idle, you can press **Line** to enter the line status screen. The line status screen is displayed below:

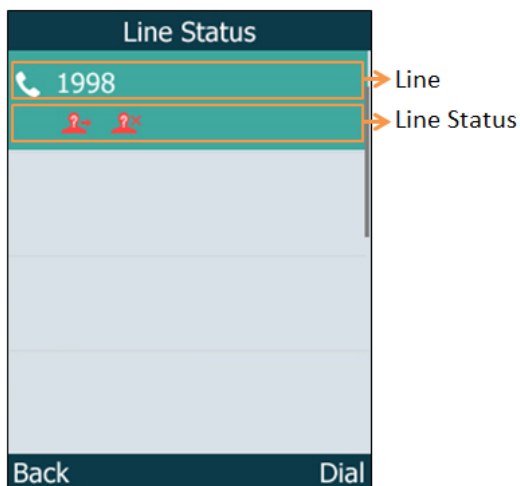





Line screen introduction

Items	Introduction
Outgoing Line	Display the registered line number and the corresponding line (display user name by default). The default outgoing line will be displayed in the first line of the screen.
Line Status	Display the icon of line status. The icon indicates the corresponding feature assigned to the line.







Icon introduction

Each icon in the line status screen indicates the corresponding feature assigned to the line.

Icons	Description
	Call forward
	Anonymous call rejection is enabled
	Unassigned outgoing line
	Do Not Disturb (DND)
	Anonymous call is enabled

Icons on the Call Screen

By viewing the icons in the calls screen, you can easily get the current call status, such as audio output mode status.

Icons	Description
	Receiver Mode On
	Hands-free Mode On
	Call Hold
	Conference Call
	Headset Mode On
	Contact
	Call Mute

How to Register Handset to Base

See [Register Devices to W70B](#) or [Register Devices to W80DM and W90DM](#) for more detailed information.

How to Place and Answer Calls

See [Place Calls](#) for detailed information.

See [Answer Calls](#) for detailed information.

How to Update Firmware

See [Update Handset](#) for detailed information.