

Poly CCX 700 Business Media Phone

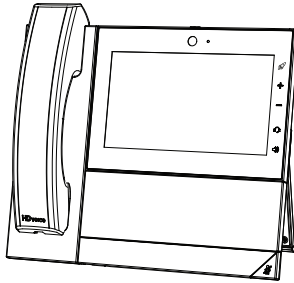

Package Contents

With Handset Cradle

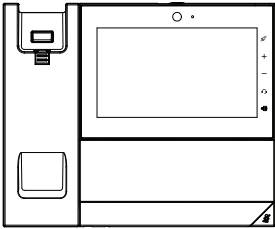

Handset



Handset Cord

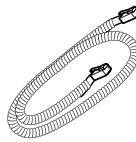

Without Handset Cradle

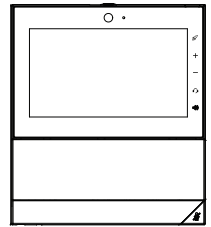

Network Cable



Setup Sheet

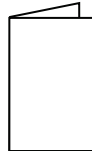

Optional Accessories



AC power adapter
(varies by region)

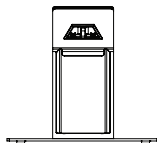

CCX Video Stand

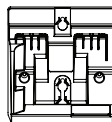

Wallmount

For more information on optional accessories, contact your reseller.

Features

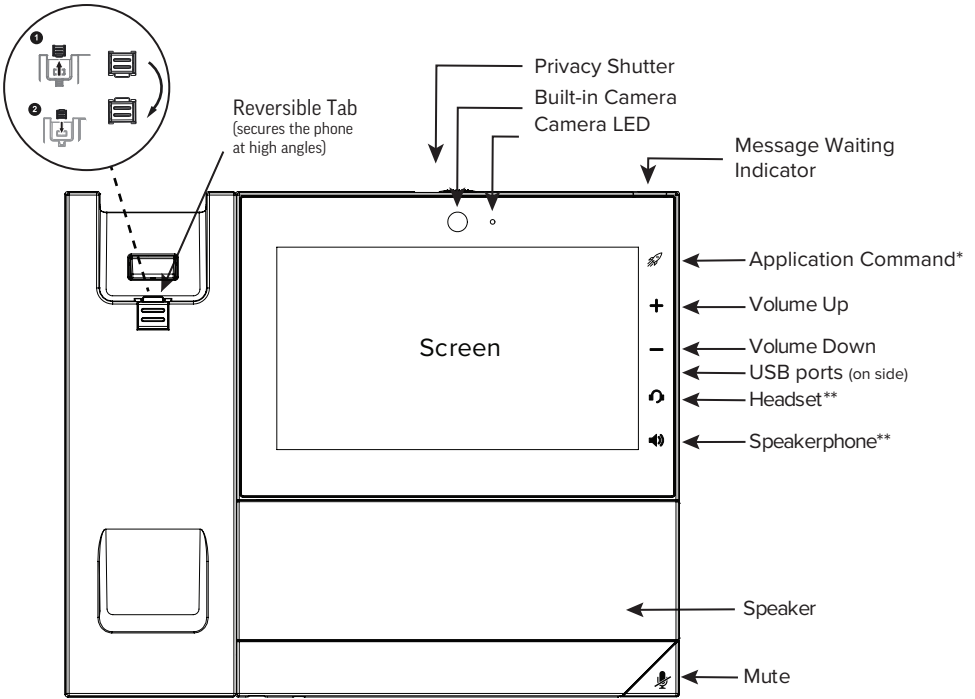

*Icon displays only when the phone is powered on and the feature is available. Icon may vary (👉👉).

**Icon displays when the phone is powered on.

Adjust the Desktop Stand

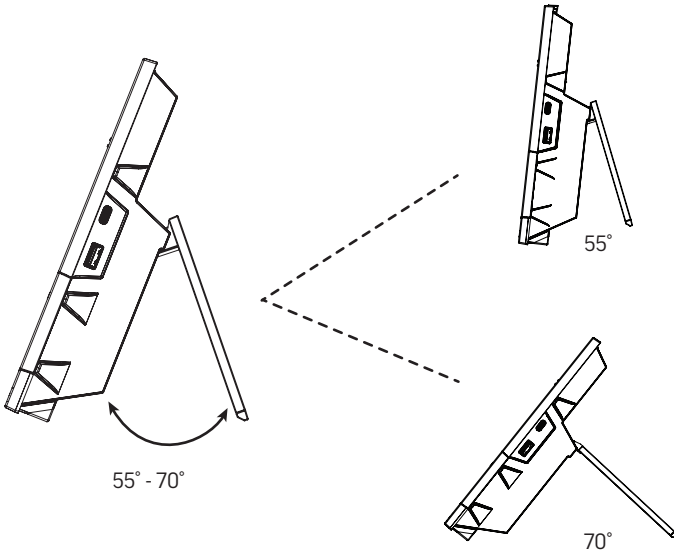

Connect Cables

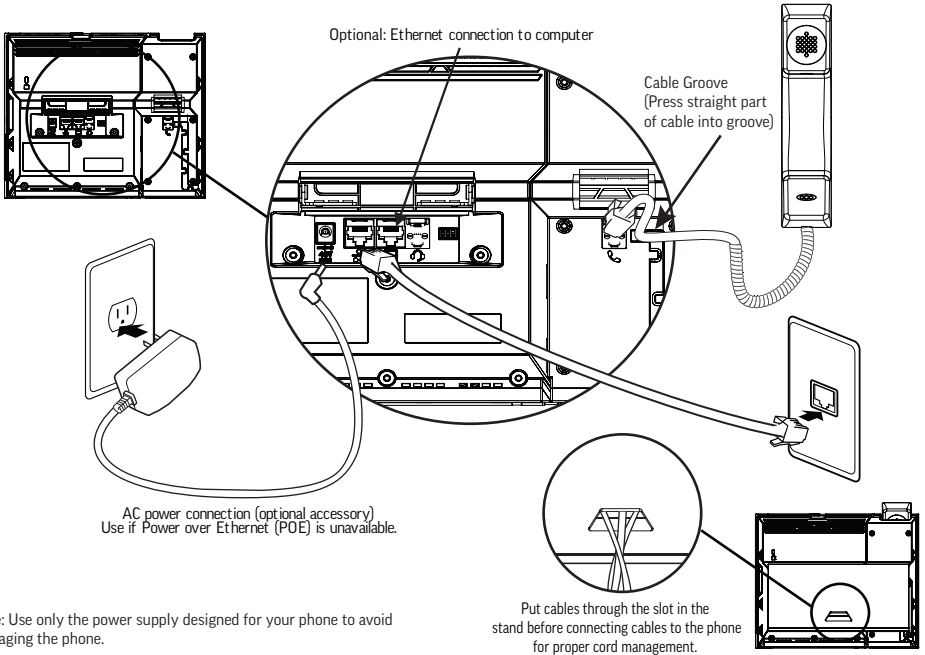

Connect Optional Headset

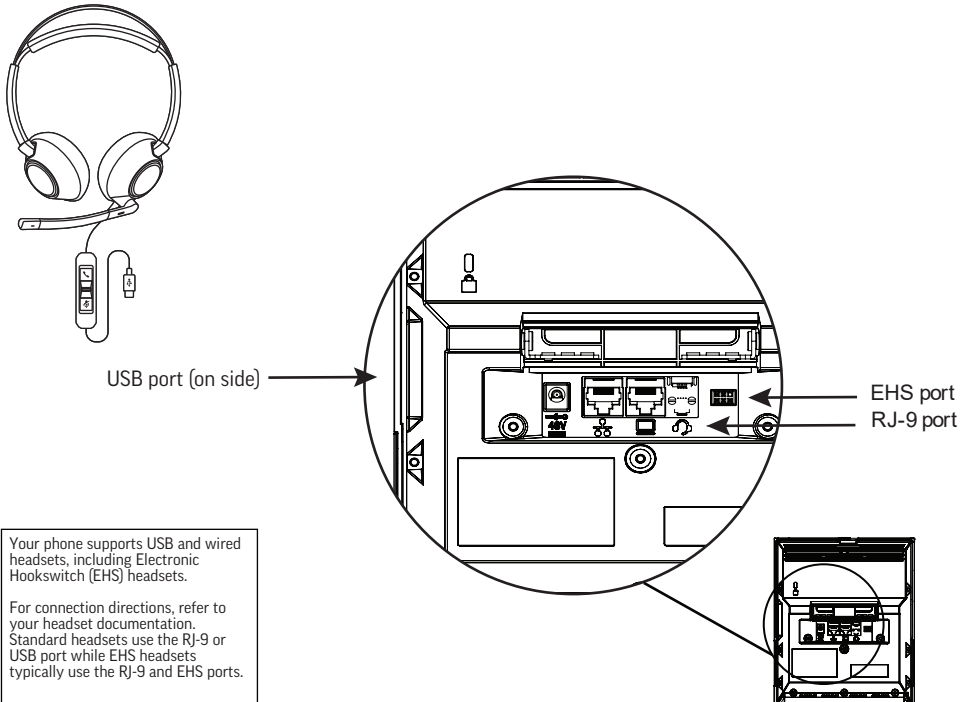



BY USING THIS PRODUCT, YOU ARE AGREEING TO THE TERMS OF THE END USER LICENSE AGREEMENT (EULA) AT:

<http://documents.polycom.com/indexes/licenses>. IF YOU DO NOT AGREE TO THE TERMS OF THE EULA, DO NOT USE THE PRODUCT, AND YOU MAY RETURN IT IN THE ORIGINAL PACKAGING TO THE SELLER FROM WHOM YOU PURCHASED THE PRODUCT.

Refer to the Limited Warranty section of the Product Warranty Guide found under Services at <http://support.polycom.com/>

Hereby, Poly declares that the radio equipment type CCX 700 is in compliance with Directive 2014/53/EU. The full text of the EU declaration of conformity is available at typeapproval@poly.com.

Frequency Range	Maximum Transmit Power
2402MHz–2480MHz	13.6 dBm
5180MHz–5210MHz	13.41 dBm
5290MHz–5320MHz	12.67 dBm
5500MHz–5700MHz	12.74 dBm

Polycom Documentation
www.polycom.com/support



Contact Information:

Contact your Authorized Reseller for Assistance.

www.poly.com

Plantronics, Inc. 345 Encinal Street Santa Cruz, California 95060

